

JACoW

Team Meeting 2023 – JTM2023

Hsinchu City, Taiwan

28 November – 1 December 2023

Robert Saethre - Rapporteur

National Synchrotron Radiation Research Center, Hsinchu City



Activity Center at NSRRC

Speakers

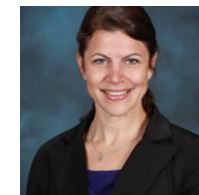

Tuesday Morning

28/11/2023

- Welcome - Ming-Chyuan Lin
- Pre-Team Meeting Report - **Ronny Billen**
- General Overview of producing JACoW proceedings - **Johan Olander**



Tuesday Morning

- What is JACoW, and What role does JACoW play in a conference?
- **David Button**
- JACoW Regional Support Centres, SPMS and Publication to JACoW.org - **Ronny Billen**
- IPAC'23 Report - **Ivan Andrian**

28/11/2023

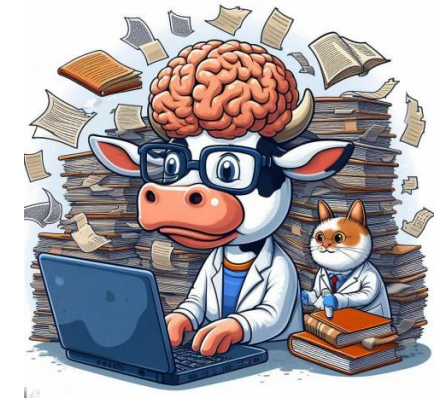

**Activity Report
Regional Support Centres**



Tuesday Afternoon

29/11/2023

- JACoW Deputy Chair position - **Ronny Billen**
- Indico activities and future directions - **Duarte Galvão**
- The future of the Central Repository - **Johan Olander**

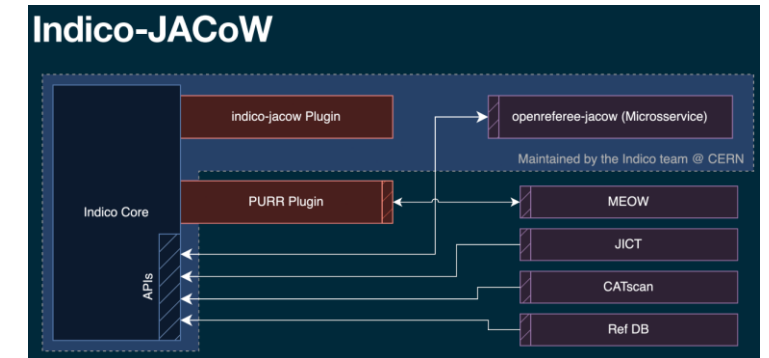

Tuesday Afternoon

- Indexing of proceedings - what, why and how - **Volker RW Schaa**
- Setting up documentation pages for your conferences series - **Ivan Andrian**
- Report about light peer review (V) - **Nicolas Delerue**
- Setup of personal laptops to use for hands-on tutorials - **Johan Olander**

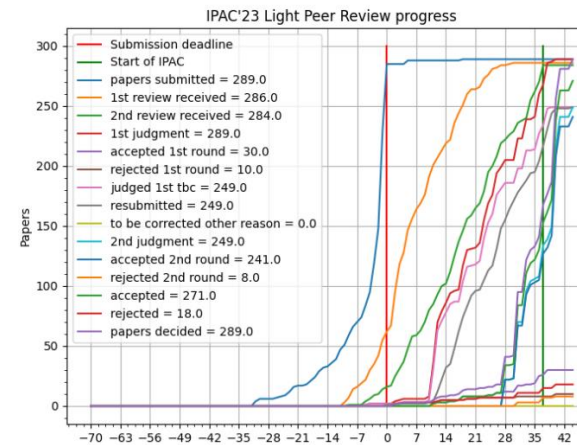
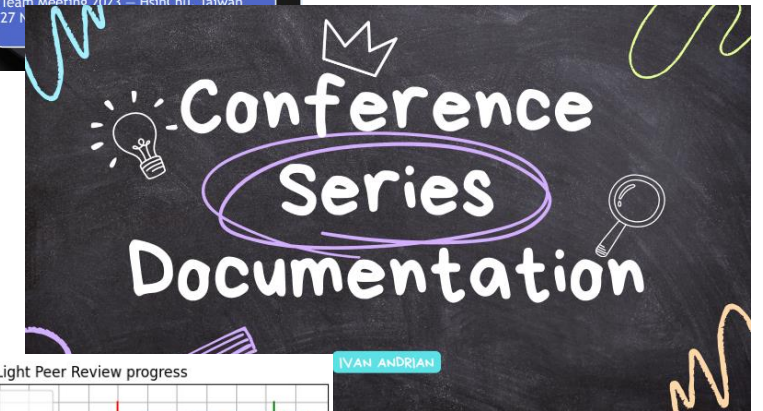

Wednesday Morning

29/11/2023

What did you do yesterday?

- Feedback session and summary of day before - **Johan Olander**
- Perspectives from a new editor/collaboration member (V) - **Sumner Brown Gibbs**
- JACoW Templates - **Jan Chrin**
- CatScan tool and JACoW reference search tool and surprise template tool - **Joshua Peters**

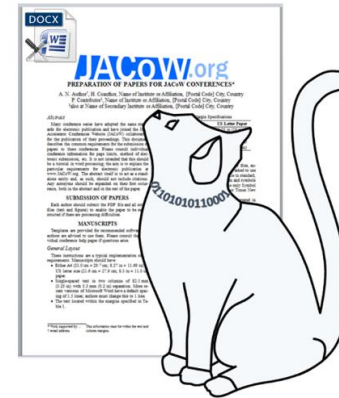

Wednesday Afternoon

29/11/2023

- Paper processing/QA workflow - **Ivan Andrian**
- Editing with L^AT_EX - **Jan Chrin**
- Editing with Word - **David Button**

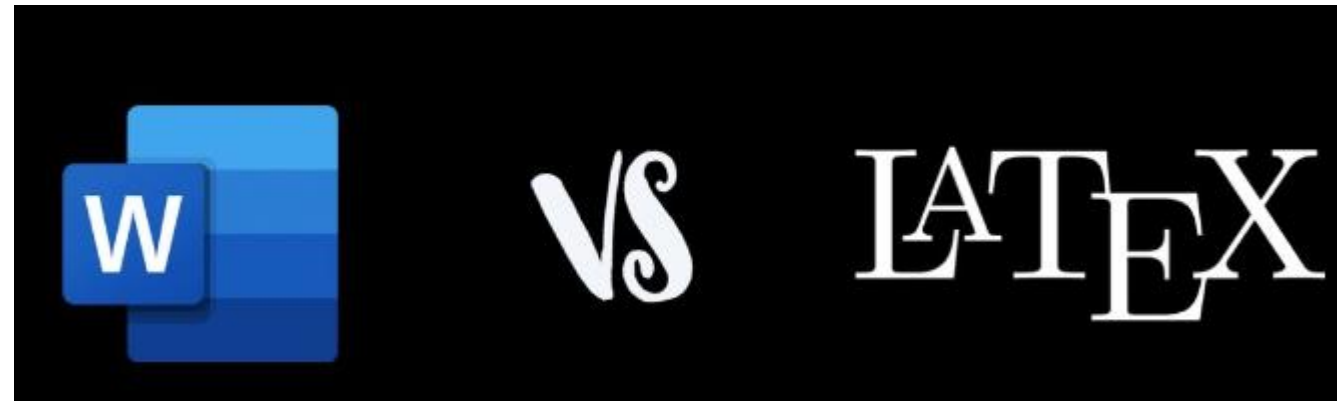
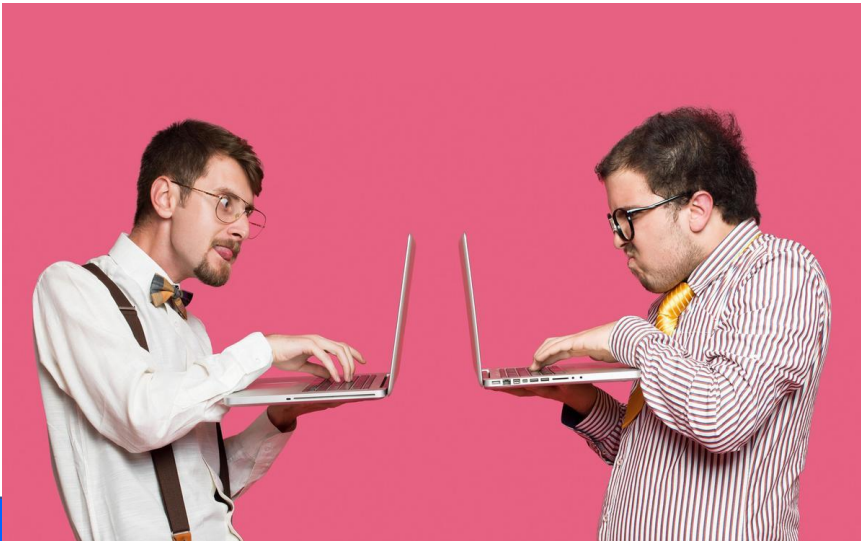

Wednesday Afternoon

- How to edit transparencies - a saga coloured by GIFs and movies (V) - **Michaela Marx**
- JACoW-Indico conference tools and information screens – **Stefano Deiuri**

How to process transparencies



Wednesday Afternoon

- JACoW-Indico Scientific Program Management - **Giulia Vinicola**
- Registration in Indico, connecting external registration systems – **Stefano Deiuri**
- Software tools and requirements, setup, and installation specifications, IT management for a conference - Davide Marcato by **Stefano Deiuri**

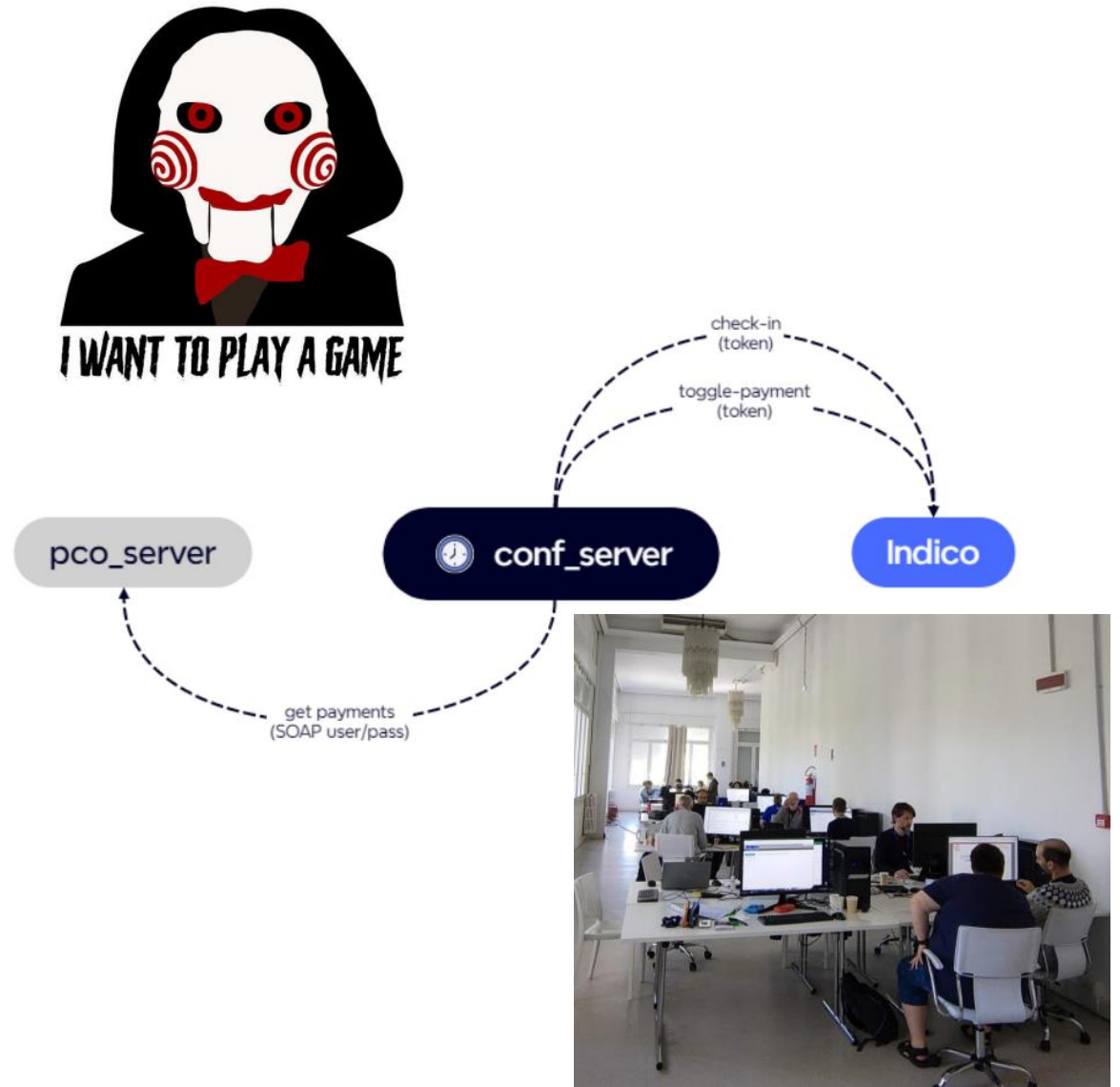

Wednesday Afternoon

- Running a successful Speaker Ready room- Davide Marcato *by Ivan Andrian*
- Trends in paper submission: Types, problems, quality control advice - **Volker RW Schaa**

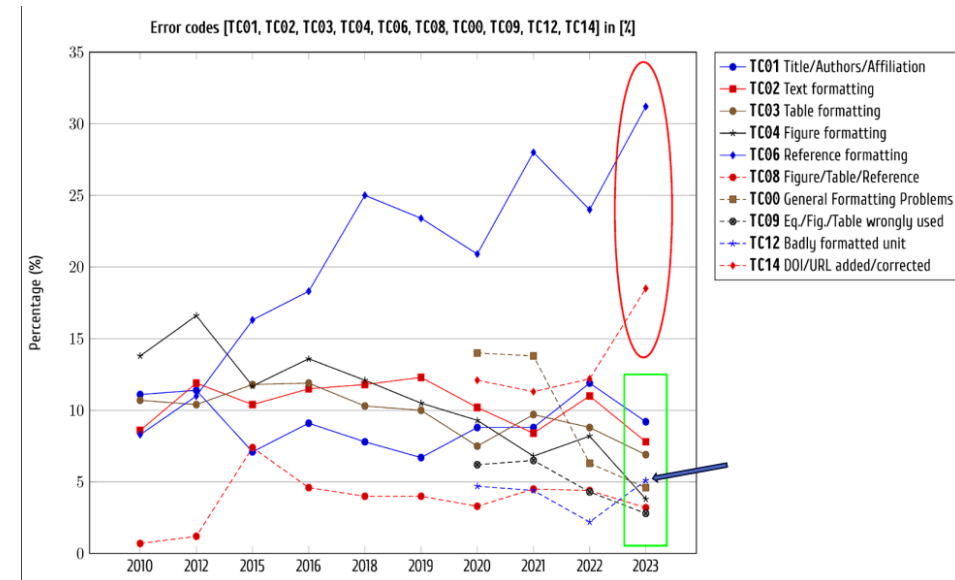
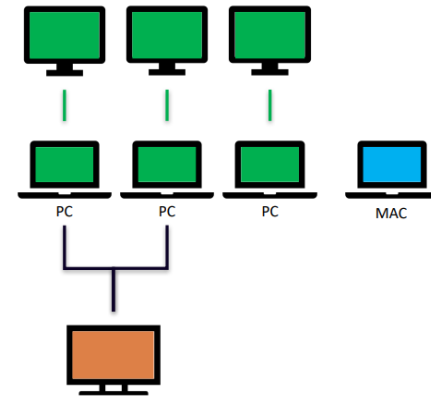

Thursday

30/11/2023

- Tutorial - working through an example conference - **Ivan Andrian**



Night Market



Hotels and getting to the NSRRC



JTM 2023



28 November to 1 December 2023

JTM23 – HsinChu City, Taiwan

JACoW